

Chambrier

Model: BD208

Dual System Draft Beer Dispenser



INSTRUCTION MANUAL

Chambrer

Many thanks and congratulations on your purchase of the Chambrer Draft Beer Dispenser!

We are confident that the Draft Beer Dispenser will be a great addition to your gatherings, no matter what the occasion!! Enjoying a cool fresh tapped beer at home is an experience we are sure you will celebrate!

You can easily move your Beer Dispenser to the where the action is! It's small and light enough that you can have it in the TV room when your friends come over to watch the game. Set it on the terrace for the BBQ, or in any other room where the party is going on!

The Chambrer Draft Beer Dispenser is especially designed to fit a wide variety of the traditional 5 liter mini kegs which are commonly available on the market.

Please take a short moment to read through the manual so you can get more familiar with your Chambrer Draft Beer Dispenser.

Unit Description:

- 1) Main unit
- 2) Keg cavity
- 3) Pressurized Tapping system
- 4) Non-Pressurized Tapping system
- 5) Keg Adapter and Handle
- 6) Drip Tray and cover
- 7) Glass holder tray
- 8) Pressure control knob
- 9) Power indicator light
- 10) CO2 Access Door

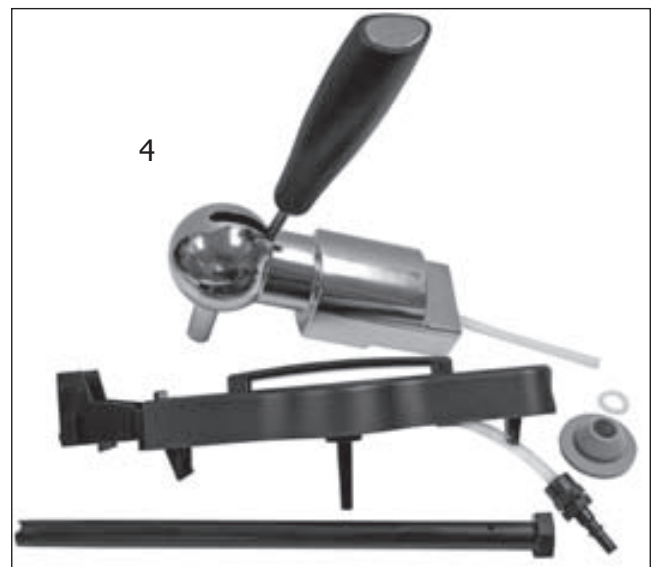

READ AND SAVE THESE IMPORTANT SAFETY INSTRUCTIONS BEFORE USING THIS APPLIANCE:

When using an electrical appliance, basic precautions should always be followed to reduce the risk of fire, electric shock, and injury to persons, including the following:

1. Use this appliance only as described in this manual. Other uses not recommended may cause fire, electric shock or personal injury.
2. This product is intended for household use ONLY and not for commercial industrial or outdoor use.
3. To protect against electric shock, do not immerse unit, plug or cord in water or spray with liquids.
4. Close supervision is necessary when any appliance is used by or near children.
5. Unplug the appliance from the outlet when not in use, when moving from one location to another and before cleaning.
6. To disconnect the appliance, grip the plug and pull it from the wall outlet. Never pull by the cord.
7. Do not operate the appliance in the presence of explosive and/or flammable fumes.
8. Do not place the appliance or any of its parts near an open flame, cooking or other heating appliance.
9. Do not operate the appliance with a damaged cord or plug, if the product malfunctions, or if it is dropped or damaged in any manner.
10. The use of attachments not recommended by the manufacturer may be hazardous.
11. Place the unit on a dry level surface.
12. Do not operate if the housing is removed or damaged.
13. A loose fit between the AC outlet (receptacle) and plug may cause overheating and a distortion of the plug. Contact a qualified electrician to replace loose or worn outlet.
14. This appliance is designed to be free standing only, and should not be recessed or built-in (fully recessed).
15. Locate the unit away from direct sunlight and sources of heat (stove, heater, radiator, etc.). Direct sunlight will affect / alter the outside color of the appliance.

WARNING: To reduce the risk of fire, electric shock or personal injury, unplug or disconnect the appliance from the power supply before servicing.

SAVE THESE INSTRUCTIONS FOR FUTURE USE

SAFETY INFORMATION

Intended use:

This appliance has been manufactured exclusively for dispensing draft beer in a domestic setting.

- This appliance should only be used in accordance with the enclosed directions for use.
- Check that your voltage corresponds to that stated on the appliance.
- Never leave the appliance unsupervised when in use. Keep out of reach of children or incompetent persons.
- Only use the appliance for domestic purposes and in the way indicated in these instructions.
- Never use accessories which are not recommended by the producer. They could constitute a danger to the user and risk to damage the appliance.
- Never move the appliance by pulling the cord. Make sure the cord cannot get caught in any way. Do not wind the cord around the appliance and do not bend it. Stand the appliance on a table or flat surface.

Additional Attention: CO2 Cartridges (for use with non-pressurized kegs)

- Keep Cartridges away from children
- Cartridges are under pressure and so should be handled and stored carefully in cool environment
- Keep cartridges out of direct sunlight or near any other sources of heat.
- Only 16g cartridges are to be used with this appliance as described in this manual

Finding a good spot for your Chambrer Draft Beer Dispenser:

- Place your beer dispenser on a flat surface that is strong enough to support it with a keg.
- Allow 5 cm of space on the back side and 20 cm of space along the left and right side of the beer dispenser to allow proper ventilation.
- This draft beer dispenser is designed to be free standing only, and should not be recessed or built-in (fully recessed).
- Do not place any objects on top of the unit other than beer glasses.
- Do not locate the unit in a moist place.
- The unit's cooling system operates efficiently with an ambient temperature of less than 26°C.
- Do not locate the beer dispenser in direct sunlight.
- Always lift the draft beer dispenser from the bottom when moving. DO NOT lift from the top.

SETUP CHECKLIST

- Unit must be placed on a flat surface.
- Unit should not be placed in direct sunlight.
- Do not place unit next to a major appliance that emits large amounts of heat, such as a dishwasher, microwave, oven, barbecue, etc.
- There should be 5 cm of clear space around the back and 20 cm of space on the left and right side of unit's vents.
- Unit should not be built-in into a wall recess, cabinet or niche
- Unit should not be used in any type of enclosed area.
- Keep the unit out of dusty or moist area

OPERATION

Your Chambrer Draft Beer Dispenser will keep your 5 litre keg cool for an indefinite period of time. This Draft Beer Dispenser has built-in temperature sensors that have been programmed to automatically keep your beer chilled to 2°C – 5°C (37°F - 42°F). Therefore, your beer will automatically maintain it's ideal serving temperature for your consuming pleasure.

There are 2 options for chilling your keg prior to serving. (DO NOT put the keg into your freezer.)

Option 1: Place keg into the Chambrer Draft Beer Dispenser, turn on and leave for 24 hours.

Option 2: Place the keg into your refrigerator for 10 hours before placing it into your Chambrer Draft Beer Dispenser.

Remember to keep your Chambrer Draft Beer Dispenser out of direct sunlight and away from any other direct sources of heat.

To get started, unpack your Draft Beer Dispenser and all the accessories included in the packing and familiarize yourself with the unit. Clean all the parts as thoroughly. Unwind the power cord in the back of the unit and before plugging it in and be sure to check that the rated voltage is the same as stated on the label on the back of the unit.

We suggest you turn the unit "On" before you begin to prepare inserting the keg in order to give the system time to beginning cooling the storage cavity.

PRESSURIZED KEG OPERATION



You will require these parts to connect your pressurized keg.

Connecting the Keg Adapter:



1. Put tap handle on beer tap (you will only do this step this one time.)



2. Insert silicone tube through tapping system (black) and attach to beer tap (slide downward into place).

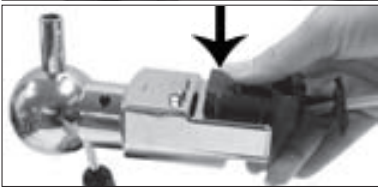

3. Place white ring over silicone tube.



4. Insert blue pin into end of tube as shown (use firm pressure to insert pin into tube).



** PLEASE NOTE: the factory will have pre-assembled the keg adapter for use with a pressurized keg.



5. Place red ring onto the top of the keg. Pressing down gently until it clicks into place.



***MAKE SURE TAP IS IN CLOSED POSITION**



6. Connect keg adapter onto top of the keg, pushing down until it clicks into place.



7. Insert blue pin into hole in the top of the keg and align tabs within red ring.



8. Slide white ring down over pin. Push down on blue pin while tightening white ring. Do not over tighten.

Using keg handles carefully lift and place into the keg cavity of the dispenser. Close the lid gently.

Your beer is ready to be served. Cheers!

Removing Pressurized Tapping System from the Keg.

After removing the keg from the Chamber Draft Beer Dispenser, proceed with the following:

1. Unscrew the white ring from the top of the keg.
2. Remove the blue pin from the hole in the top of the keg.
3. Disconnect the keg adapter from the keg by pulling gently on the tab (picture) and lifting upwards.

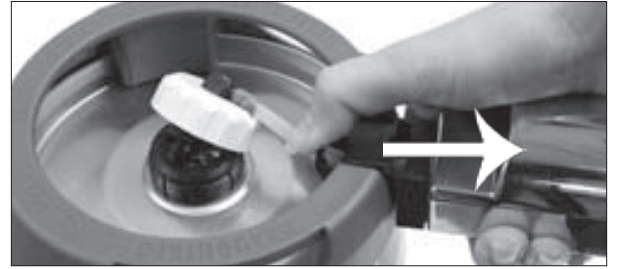

4. Carefully remove the red ring from the top of the keg. To do so, insert finger into center of ring and while pulling gently upwards, move piece in a circular motion to disconnect.



Disassembly of Pressurized Keg Tapping System

1. Carefully remove the blue pin from the end of the silicone. Hold firmly on the silicone tube close to the pin to avoid excessive stretching of the silicone tube while pulling the pin out.
2. Remove white ring and set aside.
3. Remove the tapping system from the beer tap by lifting upwards while wiggling. Take care to not damage the silicone tube or the beer tap.
4. Place all of the pieces back into the Keg Accessory Box to avoid misplacing any pieces.



NON-PRESSURIZED KEG OPERATION

Preparing the Keg

Before you place your favorite pre-cooled 5 litre keg into the Chambrer Draft Beer Dispenser you must first decompress it!

During this procedure be sure not to shake the keg as this will create suds and when piercing the keg the foam will come out.

Follow the directions on the keg and pour 1/2 a glass of beer.

Now that you have decompressed the keg we suggest you let it settle for a short time (20-30min) before proceeding with the insertion of the tap system.

Assembling the Adaptor and Tapping the Keg

To assemble the Non-Pressurized keg system. You will require these parts:



1. Put tap handle on beer tap (see page 6).

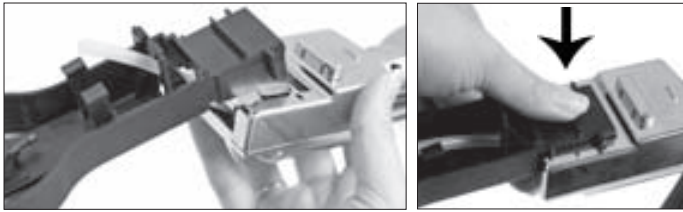

2. Insert silicone tube through tapping system (black) and attach to beer tap (slide downward into place).

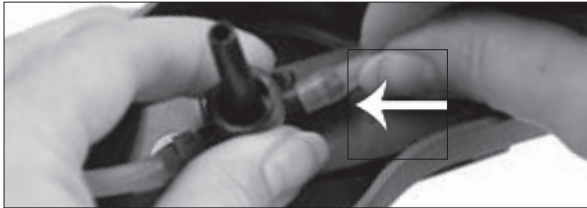

3. Attach silicone tube to tapping system.

4. Insert silicone seal into the top of the tapping tube and attach tapping tube to tapping system.



5. If the tapping tube does not fit snugly into the venting plug / adaptor currently on the keg, then you will have to remove it and replace with it with the provided grey plug and silicone gasket.

6. Lubricate the tube that is connected to the tapping system with fresh water and insert it into the keg. (This will make it easier to insert into the plug / adaptor.)

Note: In the event you prefer to detach the tube from the tap system to do this, please pay attention not to lose the silicon seal in the screw hole of the tube!

7. Take the tapping system (with tube attached) and align the bottom of the tube with the plug on the top of the keg. Center the force with your other hand in the middle of the tapping system at the top of the tube and slowly begin to insert the tube. There will be a small tab inside the venting plug that you push into the keg. This will not affect the taste of your beer.
8. Completely insert the tube into the keg until the tap system is fully attached to the keg.
9. There are "clips" on either side of the bottom of the tapping system which will lock the unit onto the keg. Once the tap system is attached you can lift the keg using the integrated handle on the tap system. Open the Chambrer Draft Beer Dispenser cover using the latch on the right side of the unit, and then insert the keg. Take care not to "drop" the keg into the cavity as this will create suds in the beer.



10. Once the keg is set in place in the unit, plug in the CO2 inlet tube (which is set at the back of the tap system) into the unit.

Be sure the connection is tight from the tube to the unit otherwise CO2 will escape!



Connecting the CO2 Cartridge

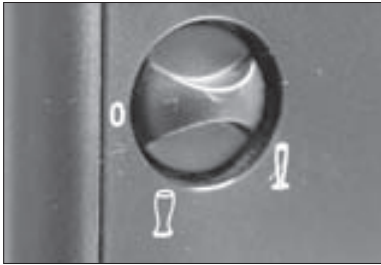

1. Be sure to turn the pressure control knob on the side of the unit to the "0" position!

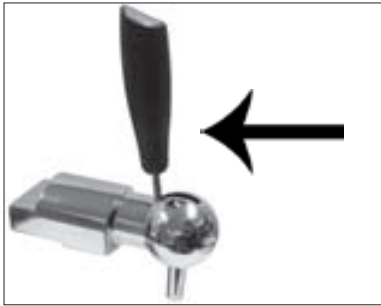

***MAKE SURE TAP IS IN CLOSED POSITION**



2. On the side of the unit is the CO2 access panel for the CO2 cartridge. Open the door and swing CO2 cartridge holder out. Unscrew holder clockwise to remove.

NOTE: Before proceeding confirm that the pressure control knob is set to "0" position to avoid the CO2 escaping!



3. Insert a 16g CO2 cartridge into the cartridge holder and screw the holder back on again. Some force will be needed when screwing the cartridge holder back on, in order to pierce the

CO2 cartridge and secure it firmly into position. During this process you will hear a short burst of air as the cartridge is pierced. It is important to do this procedure quickly to avoid an excessive amount of CO2 escaping.

Do not attempt to remove the cartridge again because it is now under pressure!

4. Let the holder swing down into its original position and close the CO2 access panel door.
5. Wait 10-30 minutes before selecting preferred pressure with the pressure control knob. This will allow the CO2 to disperse throughout the system.

NOTE: When using the unit continuously, remember to set the pressure control knob back to the "0" position before replacing a fresh pre-cooled keg! Otherwise the CO2 will escape during the changing of the keg!

Pressurizing the system

With the CO2 cartridge in place and the tap system connected you are now ready to pressurize the unit. Your choice of beer will determine how much pressure you need. For most beers (Lagers and Pilsner) a low pressure is sufficient in order to tap the beer. We suggest setting the pressure control knob towards the small draft beer icon. For wheat beers and Guinness we suggest to set the pressure control knob towards the large draft beer icon.

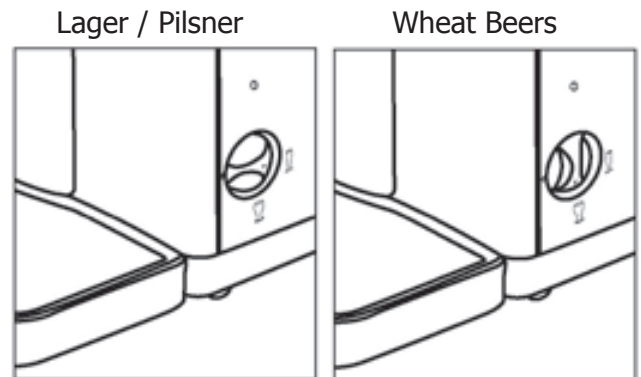

You are now ready to enjoy! Cheers!

Removing Non-Pressurized Tapping System from the Keg.

1. Turn the pressure control knob on the side of the unit to the "0" position.
2. Disconnect the CO2 inlet tube from the tapping system. Push down on white button while pulling out CO2 tube.
3. Carefully lift empty keg out of Chamber Beer Dispenser using handle on tapping system.
4. Remove tapping system by pulling gently on tab (see picture) and lifting up until the tapping tube has been completely removed from the keg.
5. Remove grey plug from the top of the keg (if used).

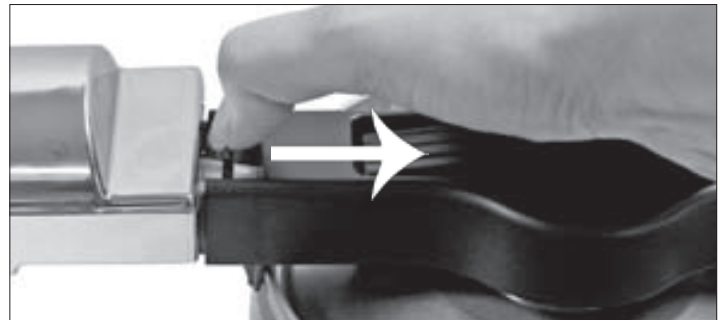

Disassembly of Non-Pressurized Keg Tapping System

1. Unscrew tapping tube from tapping system, taking care not to lose the silicone seal at the end of the tube.
2. Firmly pull on the silicone tube to disconnect it from tapping system.



3. Remove the tapping system from the beer tap by lifting upwards while wiggling. Take care to not damage the silicone tube or the beer tap.
4. Place all of the pieces back into the Keg Accessory Box to avoid misplacing any pieces.



Note:

- For optimal pressure and taste from your beer we suggest consuming a non-pressurized keg within 10-12 days.
- Depending on your pressure preference and the length of time the keg is in the unit 1 cartridge should last for 1 - 2 kegs
- To prolong the life of your CO2 cartridge, turn pressure control knob to "0" after pouring each beer.
- Leave the unit turned "On" whenever you have a keg installed to ensure the beer is kept cool and ready for consumption. This can be confirmed from the power indicator light just above the pressure control knob.
- To achieve a light yet frothy head on your beer, hold draft glass at a 45° angle to beer dispenser while pouring.

CLEANING AND STORAGE

To maintain the best results and the freshest taste of your beer, the dispenser should be cleaned each time a keg is finished and removed.

The drip tray should be cleaned after each session of use. Either daily or weekly to prevent a build-up of beer drippings that could lead to an unpleasant smelling drip tray.

Cleaning:

- Before cleaning the appliance, it is essential to turn off the main switch and then pull the plug out of the socket.
- Never immerse the appliance in water!
- Do not attempt to access any internal parts of the appliance.
- To clean the housing, simply wipe this unit with a damp cloth. Do not use any scouring pads or abrasive cleaners as these will result in scratches to the unit.
- The drip tray and cover can be removed from the unit (either separately or together) by lightly lifting the tray vertically from the unit. After cleaning, the tray and cover can be locked back into place in the same manner.
- The glass holder tray can be removed for cleaning insert your fingers underneath to lift out the tray. side and then lightly press the opposite side back

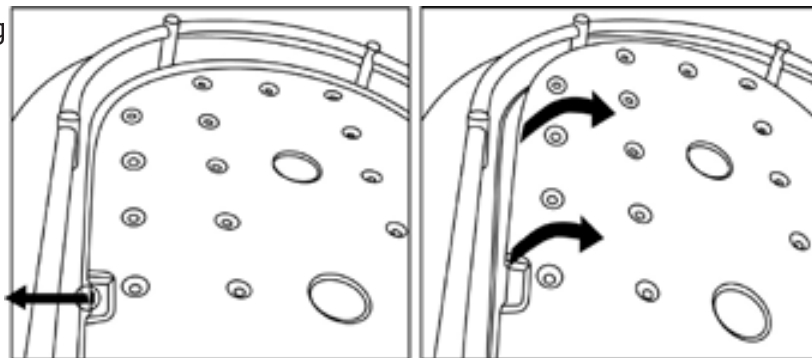

Cleaning the tapping system

- The tapping system can be cleaned with the provided cleaning accessories as follows:

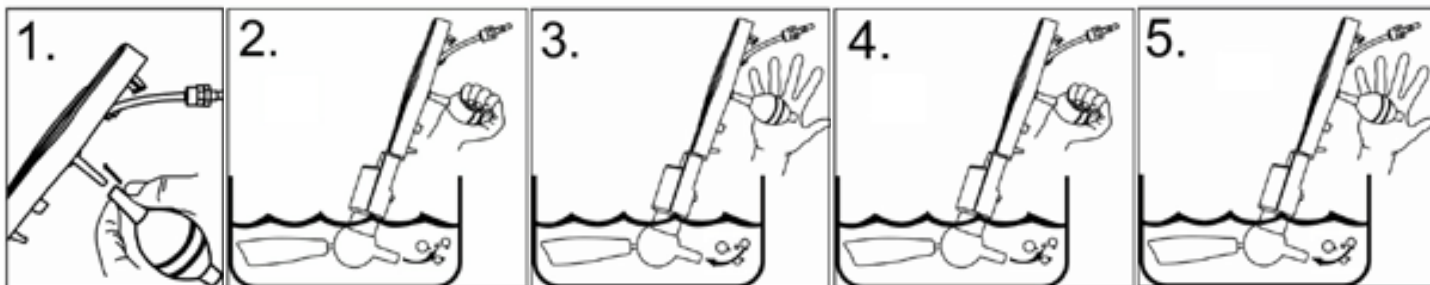

1. Remove the tube of the tapping system. The tube can be washed separately in warm soapy water. Take care not to lose the silicon seal that is located at the opening of the tube. Once the tube is removed, connect the cleaning pump to the tapping system.
2. Open the tap so that the handle is in the lower position, as when serving a beer. Immerse the tap in soapy water. Press firmly on the cleaning pump, air should come out of the tap.
3. Release the cleaning pump; air will be pulled into the tapping system and the pump. When the pump is full of water, press firmly on it to expel the water.
4. Repeat a few times to remove all beer residue.
5. Repeat with clear water a few times to ensure that the system is rinsed thoroughly and that there is no beer or soap residue.

STORAGE:

When the appliance is not used for a long period of time, remove the plug from the wall socket, clean and dry thoroughly and store the appliance in a dry place out of children's reach.

CHAMBRER APPLIANCE WARRANTY

We appreciate your purchase of a CHAMBRER DRAFT BEER DISPENSER. We take pride in the quality of our products and have manufactured your new CHAMBRER DRAFT BEER DISPENSER to exacting quality standards. We feel confident that in normal use, it will provide you with satisfactory performance. However, should you experience difficulty; you are protected under the provisions of this warranty. CHAMBRER DRAFT BEER DISPENSER is warranted against manufacturing defects in materials and workmanship in normal use for the following periods from the date of purchase by the original user, and is conditional upon the unit being installed and used as directed in the instruction manual.

WARRANTY PERIOD CHAMBRER DRAFT BEER DISPENSER Carry-in Service: One (1) year Parts and Labour

PSI's obligation under this warranty should be limited to the repair, including all necessary parts and the labour connected therewith, or at our option the exchange of any CHAMBRER DRAFT BEER DISPENSER which shows evidence of a manufacturing defect within the warranty period. Replacement parts, furnished in connection with this warranty shall be warranted for a period equal to the unexpired portion of the original equipment warranty.

CUSTOMER OBLIGATIONS

This warranty applies to the product from the original date of purchase at retail. Therefore, the owner must provide a copy of the original, dated bill of sale. No warranty service will be performed without a bill of sale. Transportation to and from the service depot is the responsibility of the owner.

WARRANTY EXCLUSIONS

This warranty is extended to CHAMBRER DRAFT BEER DISPENSER purchased and used in Canada & USA. This warranty shall not apply to appearance or accessory items including but not limited to: cabinet, cabinet parts, knobs, CO2 cartridges, kegs, tapping system. This warranty shall, in addition, not apply to damages due to handling, transportation, unpacking, set-up, installation, customer adjustments that are covered in the instruction book, repair or replacement of parts supplied by other than the authorized service depot, any malfunction or failure caused by or resulting from abnormal environmental conditions, improper unauthorized service, improper maintenance, modifications or repair by the consumer, abuse, misuse, neglect, accident, fire, flood, or other Acts of God, and incorrect line voltage. This Appliance product is only warranted to the original retail purchaser. This warranty becomes void in the event of commercial or rental use. This warranty becomes void in the event serial numbers are altered, defaced or removed. PSI reserves the right to make changes in design or to make additions to or improvements upon this product without incurring any obligation to install the same on products previously manufactured. The foregoing is in lieu of all other warranties expressed or implied and PSI neither assumes nor authorizes any person to assume for it any other obligation or liability in connection with the sale or service of this product. In no event shall PSI or its dealers be liable for special or consequential damage arising from the use of this product, or for any delay in the performance of this warranty due to cause beyond our control. The purchaser may have other rights under existing provincial or federal laws, and where any terms of this warranty are prohibited by such laws, they are deemed null and void, but the remainder of the warranty shall remain in effect. Under no circumstances shall Chamber be liable for any special incidental, indirect or punitive damages or for any consequential damages, including spoilage of beer, even if Chamber knows or is informed that such damages are possible. It is your responsibility to insure your beer, and take all reasonable, necessary precautions to safeguard its condition.

HOW TO OBTAIN SERVICE

Should this product require service, you may obtain specific information on how to obtain service by contacting the dealer from whom this product was purchased, or by contacting us directly:

Chamber Service Centre
Unit #6, 10 Carlow Court, Whitby, Ontario, L1N 9T7, CANADA
1-877-259-7989 FAX (905) 668-5204 www.chamber.com